



MOP-TFT800480-70A-BLM-CTB

Hardware Manual

Revision 1.0

Revision History

Revision	Date	Description	Author
1.0	February 21, 2018	Initial Release	Divino



Contents

- Revision History 1
- Contents 2
- 1 General Information 3
- 2 Absolute Maximum Ratings..... 3
- 3 Electrical Characteristics..... 3
- 4 Backlight Characteristics..... 3
- 5 Touch Panel Characteristics 4
- 6 External Dimensions 5
- 7 Electro-Optical Characteristics 6
- 8 Interface Description 7
 - 8.1 TFT Module Interface Description 7
 - 8.2 CTB Interface Description 7
- 9 AC Characteristics 8
 - 9.1 Pixel Timing..... 8
 - 9.2 Data Timing..... 9
 - 9.3 Touch Panel Timing..... 9
- 10 Power Sequence 10
 - 10.1 Power Up Sequence 10
- 11 Inspection Criterion 11
 - 11.1 Description 11
 - 11.2 Sampling Plan and Reference Standards 11
 - 11.3 Inspection condition 11
 - 11.4 Definition of Inspection Zone in LCD 11
 - 11.5 Function Defect 11
 - 11.6 LCD Pixel Defect 12
 - 11.7 Dot and line defect 12
- 12 Handling Precautions..... 13
 - 12.1 Mounting method 13
 - 12.2 LCD Handling and Cleaning Precaution 13
 - 12.3 Static Charge Precaution 13
 - 12.4 Packing..... 13
 - 12.5 Precautions during Operation 13
 - 12.6 Storage Recommendations 14
 - 12.7 Safety Precautions 14
- 13 Ordering 15
 - 13.1 Part Numbering Scheme..... 15
 - 13.2 Options 15
- 14 Contact 15



1 General Information

No.	Item	Contents	Unit
1	LCD size	7.0 inch (Diagonal)	/
2	LCD type	TN/Normally white/Transmissive	/
3	Viewing direction(eye)	12 O'clock	/
4	Gray scale inversion direction	6 O'clock	/
5	Resolution(H*V)	800*480	/
6	Module size (L*W*H)	164.9*100.0*5.4	mm
7	Active area (L*W)	153.84*85.63	mm
8	Pixel pitch (L*W)	0.1923*0.1784	mm
9	Interface type	RGB Interface	/
10	Module power consumption	0.462(Without backlight)	W
11	Back light type	LED	/
12	Driver IC	HX8264+HX8664 or compatible	/
13	Weight	179	g

2 Absolute Maximum Ratings

Item	Symbol	Min.	Max.	Unit
Power supply input voltage (LCM)	VDD	-0.5	5.0	V
Backlight current (normal temp.)	ILED	-	75	mA
Operation temperature	Top	-20	70	°C
Storage temperature	Tst	-30	80	°C
Humidity	RH	-	90%(Max60°C)	RH

3 Electrical Characteristics

DC Characteristics (at Ta=25 °C)

Item	Symbol	Min.	Typ.	Max.	Unit
Power supply input voltage (LCM)	VDD	2.7	3.3	3.6	V
I/O logic voltage	VDDIO	N/A	N/A	N/A	V
Input voltage 'H' level	VIH	0.7VDD	-	VDD	V
Input voltage 'L' level	VIL	0	-	0.3VDD	V
Power supply current	IVDD	-	140	-	mA
TFT gate on voltage	VGH	-	18	-	V
TFT gate off voltage	VGL	-	-8	-	V
Analog power supply voltage	AVDD	-	10.3	-	V
Differential input common mode voltage	Vcom	-	3.4	-	V

4 Backlight Characteristics

(at Ta=25 °C, RH=60%)

Item	Symbol	Min.	Typ.	Max.	Unit	Note
LED forward voltage	VF	-	25.6	-	V	IF=60mA
LED forward current	IF	-	60	-	mA	
LED power consumption	PLED	-	1.536	-	W	*Note
Number of LED	-		24		PCS	
Connection mode	-	8 in series *3 in parallel			/	
LED life-time	-	20000	-	-	Hrs	**Note

***Note:** Calculate Value for reference ILED×VLED x LED Quantity= PLED

****Note:** The LED Life-time is defined as the estimated time to 50% degradation of initial brightness at Ta=25°C and IF =60mA. The LED lifetime could be decreased if operating IF is larger than 60mA, and increased if IF is less than 60mA.



5 Touch Panel Characteristics

(at Ta=25 °C)

Item	Description
IC solution on TP Model	GT911*
Touch Count Max	5 point
Display Resolution	800*480
Interface Type	I2C
Maximum Clock Speed	400Kbps
Interrupt Signal	Active Low
Default Origin	Upper Left Corner
Default I2C Address (Write/Read)	0xBA/0xBB

Parameter	Min.	Typ.	Max.	Unit
Power Voltage (VDD)	2.8	---	3.3	V
Signal Voltage	1.8	3.3	3.6	V
Signal HIGH	0.7*VDD	---	VDD	V
Signal LOW	0	---	0.3*VDD	V
Supply Current (Operation)	---	6.0	---	mA

*Note: For more information, see the GT911 datasheet.



6 External Dimensions

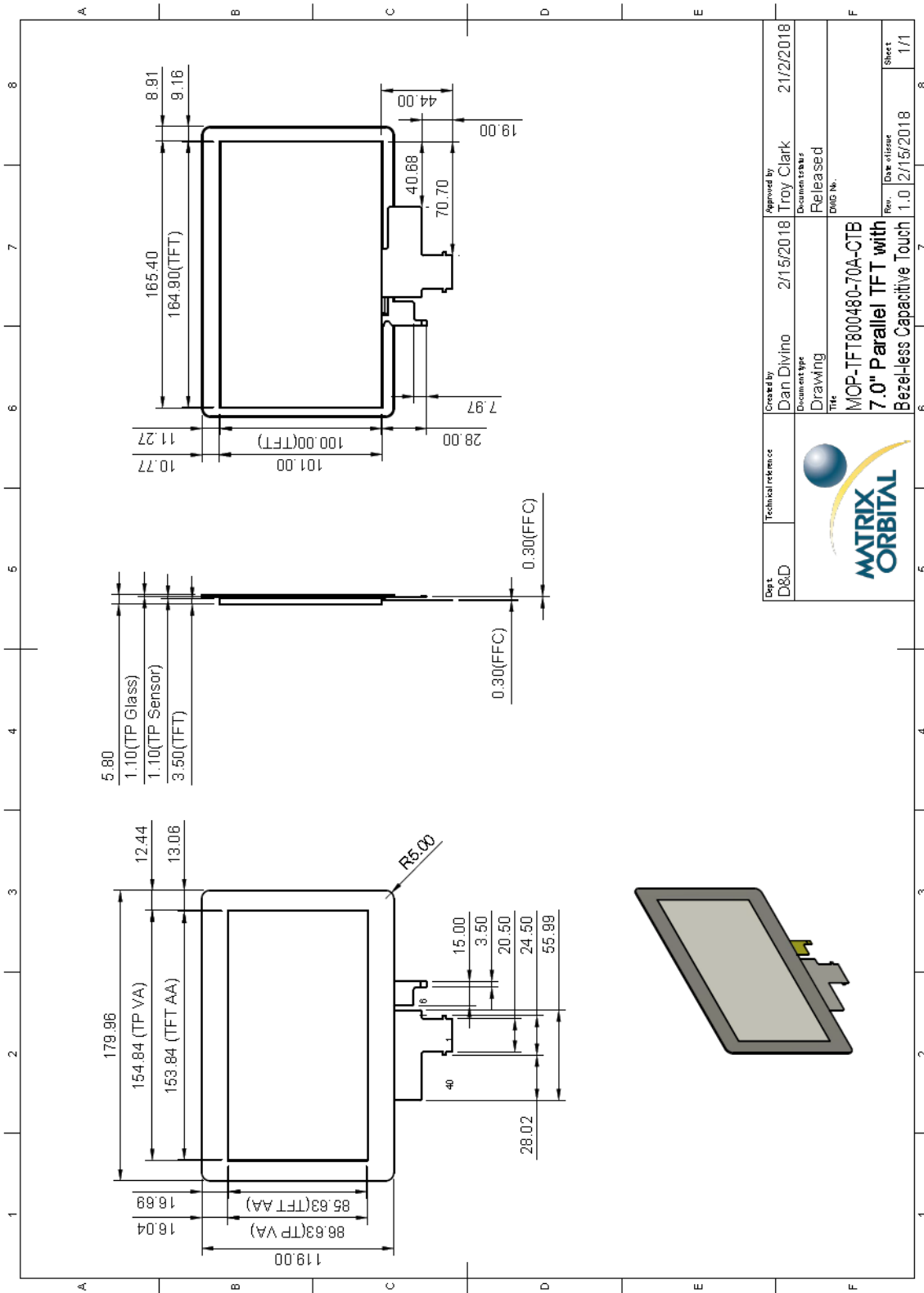

Dept.	D&D	Created by	Dan Divino	2/15/2018	Approved by	Troy Clark	21/2/2018
Technical reference		Document type	Drawing		Document status	Released	
		Title	MOP-TFT800480-70A-CTB 7.0" Parallel TFT with Bezel-less Capacitive Touch				
					Rev.	1.0	Date of issue
						2/15/2018	1/1

Figure 1: MOP-TFT800480-70A-BLM-CTB Drawing



7 Electro-Optical Characteristics

Item	Symbol	Condition	Min.	Typ.	Max.	Unit	Remark	Note
Response time	Tr+ Tf	-	-	25	50	ms	FIG.1	Note 4
Contrast ratio	Cr		400	500	-	---	FIG.2	Note 1
Surface Luminance	Lv	$\theta=0^\circ$	330	472	-	cd/m ²	FIG.2	Note 2
Luminance uniformity	δ WHITE	$\theta=0^\circ$	60	75	-	%	FIG.2	Note 3
NTSC	-	$\theta=0^\circ$	-	50	-	%	FIG.2	Note 5
Viewing angle	θ	$\varnothing = 90^\circ$	60	70	-	deg	FIG.3	Note 6
		$\varnothing = 270^\circ$	50	60	-	deg	FIG.3	
		$\varnothing = 0^\circ$	60	70	-	deg	FIG.3	
		$\varnothing = 180^\circ$	60	70	-	deg	FIG.3	
CIE (x, y) chromaticity	Red x	$\theta=0^\circ$ $\varnothing=0^\circ$ Ta=25°C	0.5378	0.5778	0.6178	-	FIG.2 CIE1931	Note 5
	Red y		0.2872	0.3272	0.3672	-		
	Green x		0.3128	0.3528	0.3928	-		
	Green y		0.5548	0.5948	0.6348	-		
	Blue x		0.1140	0.1540	0.1940	-		
	Blue y		0.0977	0.1377	0.1777	-		
	White x		0.2685	0.3085	0.3485	-		
	White y		0.3189	0.3589	0.3989	-		

***Note 1:** Definition of contrast ratio

Contrast Ratio (CR) is defined mathematically by the following formula.

$$\text{CONTRAST RATIO} = \frac{\text{Luminance measured when LCD on the "White" State}}{\text{Luminance measured when LCD on the "Black" State}}$$

***Note 2:** Definition of surface luminance

Surface luminance is the LCD luminance from the surface with all pixels displaying white.

$$L_v = \text{Average Surface Luminance with all white pixels (P1, P2, P3 ... Pn)}$$

***Note 3:** Definition of luminance uniformity

The luminance uniformity in surface luminance (Yu) is determined by measuring luminance at each test position 1 through n, and then dividing the maximum luminance of n point's luminance by minimum luminance of n points luminance.

$$Y_u = \frac{\text{Minimum Surface Luminance with all white pixels (P1, P2, P3 ... Pn)}}{\text{Maximum Surface Luminance with all white pixels (P1, P2, P3 ... Pn)}}$$

***Note 4:** Definition of Response time

The response time is defined as the LCD optical switching time interval between "White" state and "Black" state. Rise time (TON) is the time between photo detector output intensity changed from 90% to 10%. And fall time (TOFF) is the time between photo detector output intensity changed from 10% to 90%.

***Note 5:** Definition of color chromaticity (CIE1931)

CIE (x, y) chromaticity, the x, y value is determined by screen active area center position P5.

***Note 6:** Definition of Viewing angle.

Viewing angle is the angle at which the contrast ratio is greater than 10. The angles are determined for the horizontal or x axis and the vertical or y axis with respect to the z axis which is normal to the LCD surface.

For Viewing angle and response time testing, the testing data is based on Autronic-Melchers's ConoScope or DMS series Instruments or compatible. For contrast ratio, Surface Luminance, Luminance uniformity and CIE, the testing data is based on TOPCON's BM-7 or BM-5 photo detector or compatible.

***Note 7:** For TFT module, Gray scale reverse occurs in the direction of panel viewing angle.



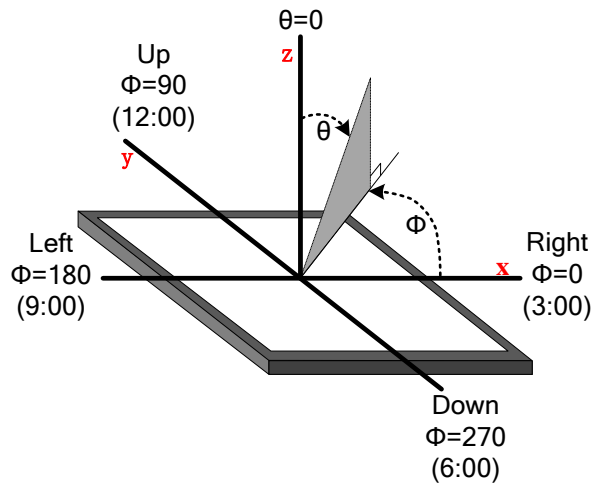

Figure 2: The definition of viewing angle

8 Interface Description

8.1 TFT Module Interface Description

Interface No.	Name	I/O Pin Connections	Description
1	LEDK	P	Power for LED backlight(Cathode)
2	LEDA	P	Power for LED backlight(Anode)
3	CS	I	SPI function chip select signal
4	VDD	P	Digital Power
5-12	R0-R7	I	Red data
13-20	G0-G7	I	Green data
21-28	B0-B7	I	Blue data
29	GND	P	Power Ground
30	DCLK	I	Clock input
31	DISP	I	Display on/off
32	HSYNC	I	Horizontal sync input. Negative polarity
33	VSYNC	I	Vertical sync input. Negative polarity
34	DE	I	Data Enable signal ;normally pull low
35	SCL	I	SPI SCL function
36	SDA	I	SPI SDA function
37	XR(NC)	/	/
38	YD(NC)	/	/
39	XL(NC)	/	/
40	YU(NC)	/	/

8.2 CTB Interface Description

Interface No.	Name	I/O Pin Connections	Description
1	RST*	I	Reset (Active Low)
2	INT*	O	State change interrupt (Active Low)
3	GND	P	Ground
4	SDA**	I/O	Serial interface data
5	SCL**	I	Serial interface clock
6	VDD	P	Power supply of CTP

*Note: Pull up resistors of 10K ohms to VDD are recommended for RST and INT.

**Note: Pull up resistors of 1K-10K ohms to VDD are required for SCL and SDA.



9 AC Characteristics

9.1 Pixel Timing

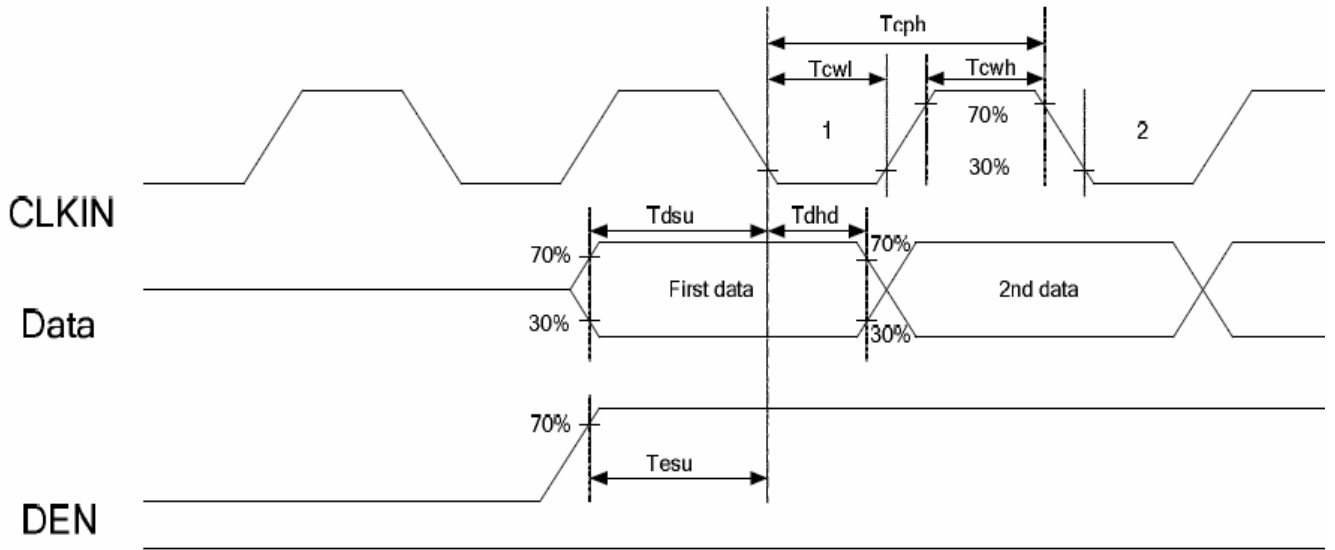

Figure 3: Clock input Data/Den timing diagram

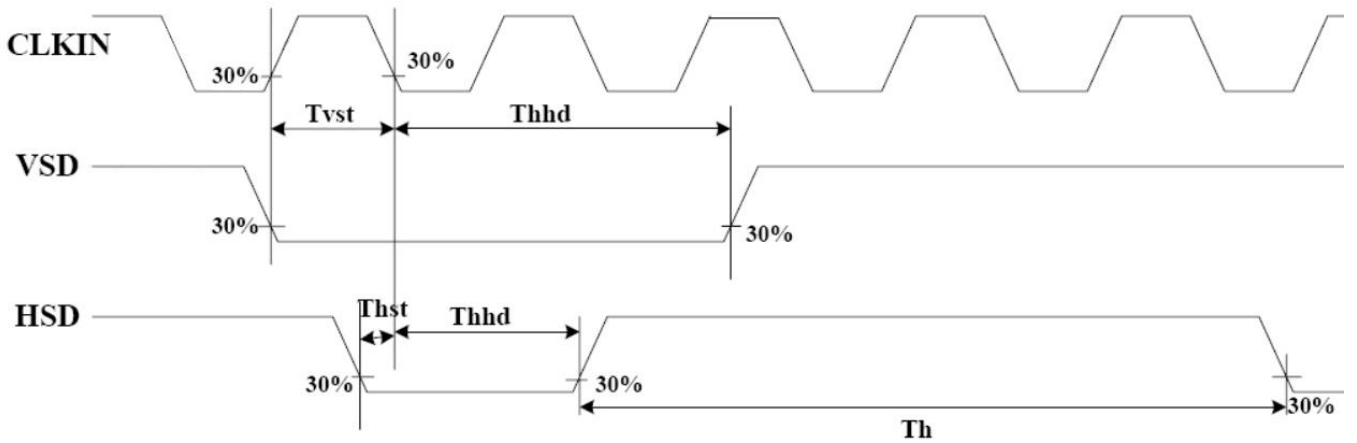

Figure 4: Data Transaction Timing in Parallel RGB (24Bit) interface (SYNC Mode)

Parameter	Symbol	Spec.			Unit	Conditions
		Min.	Typ.	Max.		
HS setup time	Thst	8	-	-	ns	
HS hold time	Thhd	8	-	-	ns	
VS setup time	Tvst	8	-	-	ns	
VS hold time	Tvhd	8	-	-	ns	
Data setup time	Tdsu	8	-	-	ns	
Data hold time	Tdhd	8	-	-	ns	
DE setup time	Tesu	8	-	-	ns	
DE hold time	Tehd	8	-	-	ns	
Dvdd power on slew rate	Tpor	-	-	20	ms	0 to 90% DVDD
RESET pulse width	Trst	1	-	-	us	
DCLK cycle time	Tcoh	20	-	-	ns	
DCLK pulse duty	Tcwh	40	50	60	%	



9.2 Data Timing

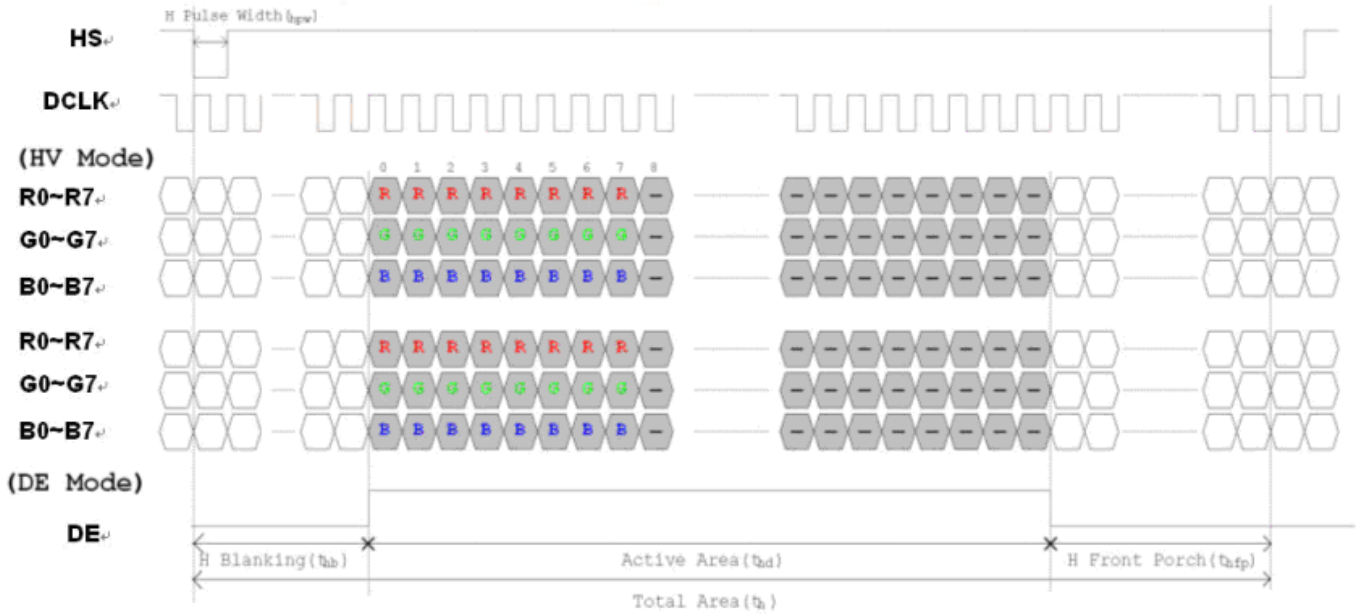

Figure 5: Horizontal Input Timing Diagram

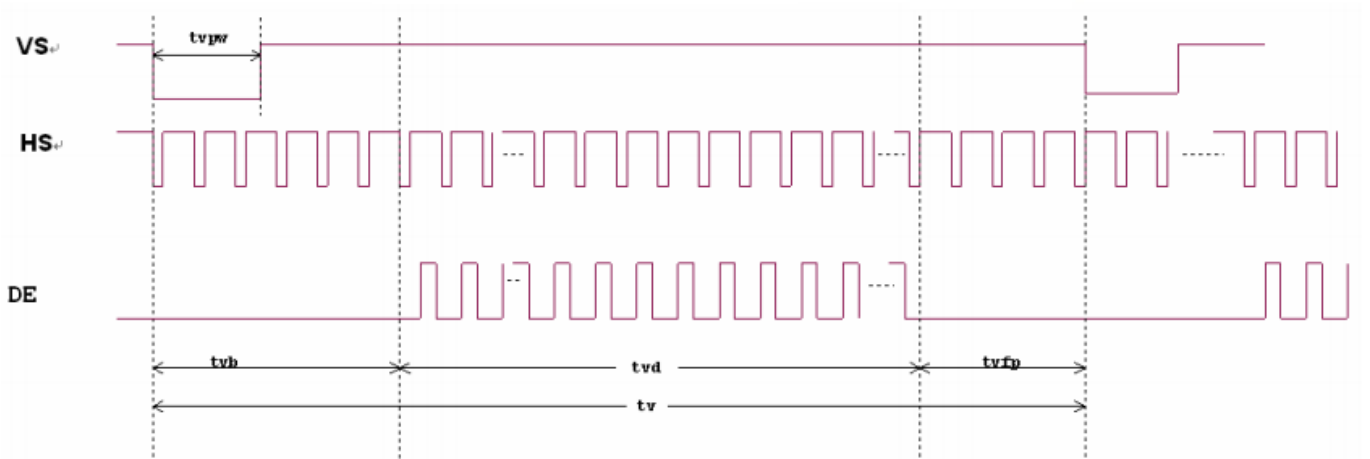

Figure 6: Vertical Input Timing Diagram

Item	Symbol	Min	Typ	Max	Unit
Horizontal Display Area	thd		800		DCLK
Dclk frequency	fclk	-	30	50	MHZ
One horizontal line	th	889	928	1143	DCLK
HS pulse width	thpw	1	48	255	DCLK
HS blanking	thb		88		DCLK
HS front porch	thfp	1	40	255	DCLK
Vertical Display Area	tvd		480		TH
VS period time	tv	513	525	767	TH
VS pulse width	tvpw	3	3	255	TH
VS blanking	tvb		32		TH
VS front porch	tvfp	1	13	255	TH

9.3 Touch Panel Timing

Table 1: Write Operation

Start	Address (Write)	ACK	Register (H)*	ACK	Register (L)*	ACK	Data (1)	ACK	...	Data (n)	ACK	End
-------	-----------------	-----	---------------	-----	---------------	-----	----------	-----	-----	----------	-----	-----

Table 2: Read Operation

Start	A (Write)	ACK	R (H)	ACK	R (L)	ACK	End	Start	A (Read)	ACK	D (1)	ACK	...	D (n)	ACK	End
-------	-----------	-----	-------	-----	-------	-----	-----	-------	----------	-----	-------	-----	-----	-------	-----	-----

*Note: For a complete list of registers and additional information, see the GT911 datasheet.



10 Power Sequence

10.1 Power Up Sequence

To prevent the device damage from latch up, the power ON/OFF sequence shown below must be followed.

Power On: VDD, VSS → VDDA, VSSA

Power OFF: VDDA, VSSA → VDD, DSS

HX8264-D08 has a power on/off sequence control function. In order to prevent the IC from power on reset fail, the rising time (t_{POR}) of the digital power supply VDD should be maintained within the given specifications. Please refer to “AC Characteristics” for more detail on timing.

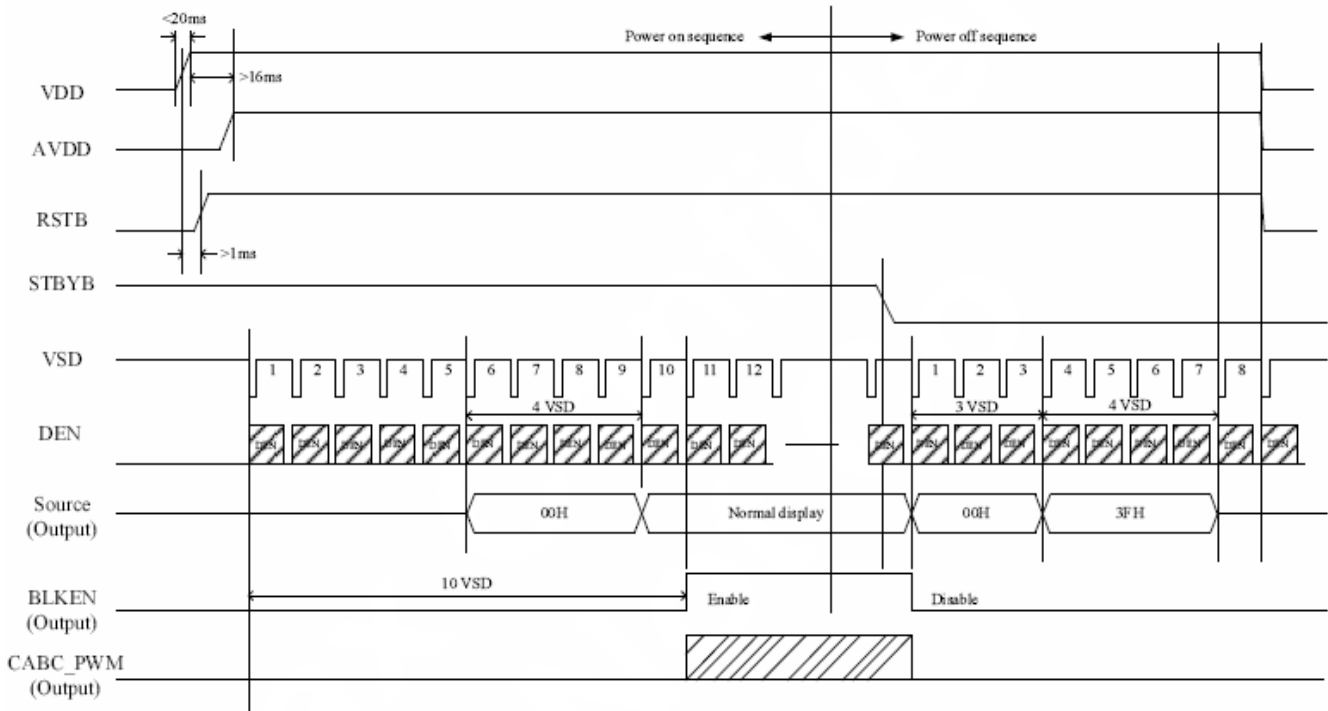

Figure 7: Power up sequence timing diagram

To prevent device latch up or power on/off sequence shown below must be followed. After VDD reaches 1.8V, VGH/VGL can start to power on. Before VDD drops to 1.8V, VGH/VGL must start to power down. After VGH/VGL start to power on, CPV and STV should not be floating, and /XAO should be at VDD level or floating. The other control signals have no timing limitation.

Power On: VDD → VGH/ VGL

Power OFF: VGH → VGL → VDD

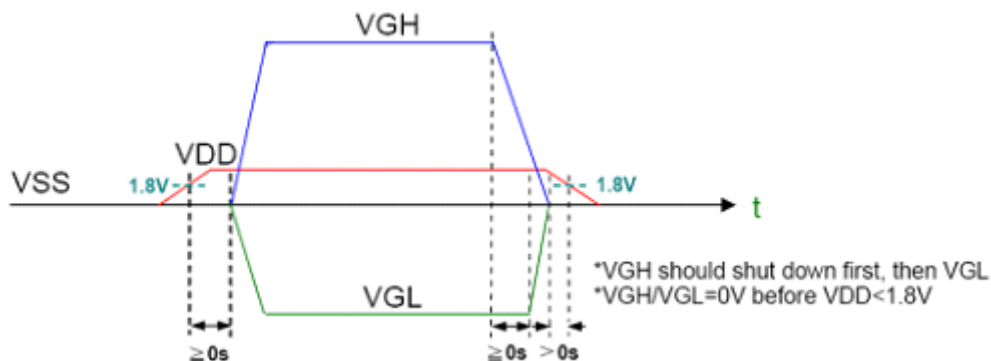

Figure 8: Device latch up timing sequence



11 Inspection Criterion

11.1 Description

This specification is made to be used as the standard acceptance/rejection criteria for the MOP-TFT800480-70A-BLM-CTB.

11.2 Sampling Plan and Reference Standards

Sampling plan according to GB/T2828.1-2003/ISO 2859-1 : 1999 and ANSI/ASQC Z1.4-1993, normal level 2 and based on:

Major defect: AQL 0.65

Minor defect: AQL 1.5

11.3 Inspection condition

- Viewing distance for cosmetic inspection is about $30\pm 5\text{cm}$ with bare eyes, and under an environment $600\sim 1000\text{lux}$ for visual inspection and $0\sim 200\text{lux}$ for function test., all directions for inspecting the sample should be within 45° against perpendicular line. (Normal temperature $18\sim 28^\circ\text{C}$ and normal humidity $60\pm 15\%\text{RH}$).
- Driving voltage
The Vop value from which the most optical contrast can be obtained near the specified Vop in the specification (Within $\pm 0.5\text{V}$ of the typical value at 25°C).

11.4 Definition of Inspection Zone in LCD

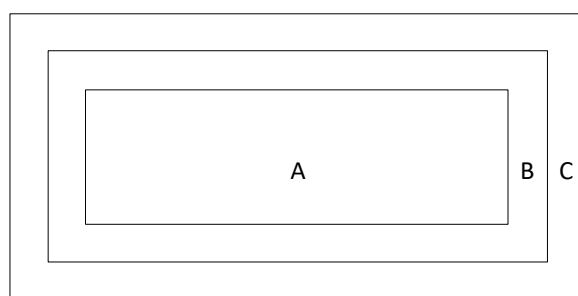

Figure 9: Inspection Zones in an LCD

Zone A: character/Digit area

Zone B: viewing area except Zone A (ZoneA + ZoneB=minimum Viewing area)

Zone C: Outside viewing area (invisible area after assembly in customer's product)

***Note:** As a general rule, visual defects in Zone C are permissible, if it does not affect display quality and assembly of customer's product.

11.5 Function Defect

Items to be inspected	Inspection criterion	Classification of defects
All functional defects	1) No display 2) Display abnormally 3) Missing vertical, horizontal segment 4) Short circuit 5) Back-light no lighting, flickering and abnormal lighting. 6) obvious striation 7) Current beyond specification value	MA
Missing	Missing component	
Outline dimension	Overall outline dimension exceed the drawing is not allowed.	



11.6 LCD Pixel Defect

(Bad Dot) (Defect type: Mi)

Item	Inspection criterion
Color bad dot-bright dot(R、G、B)	2
two adjacent bright point	1
three or more adjacent point	0
total points for bad dot-bright dot	2
Bad dot-dark dot	4
two adjacent dark point	2
three or more adjacent point	1
total points for bad dot -dark dot	6
patch bright dot	Invisible with ND5%, it is OK.

11.7 Dot and line defect

(defect type: MI)

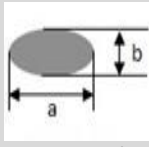
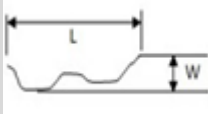
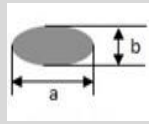
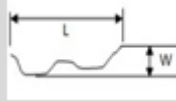
Item	Inspection criterion			Picture		
	Size	5 Inch ≤ S < 7 Inch				
Dot defect (black dot, white dot)	D ≤ 0.1	allowed		 $D=(a+b)/2$		
	0.1 < D ≤ 0.2	allowed				
	0.2 < D ≤ 0.3	5				
	0.3 < D ≤ 0.5	0				
	D > 0.5	0				
the distance between the two defect dot: DS ≥ 5mm						
Line defect (visible when power on)	Length (mm)	Width (mm)	5 Inch ≤ S < 7 Inch			
	Not count	W ≤ 0.05	Accepted			
	L ≤ 5	0.05 ≤ W < 0.1	5			
	L > 5	W > 0.1	0			
Remark: Invisible when power on, only visible in special angle against light, show as watermark/folding/scratch but cannot be touched, no control or refer to keeping sample.						
Polarizer convex-concave dot defect, polarizer bubble defect	Size(mm)	5 Inch ≤ S < 7 Inch				
	D ≤ 0.30	Accepted				
	0.30 < D ≤ 1.0	4				
	1.0 < D ≤ 1.5	2				
D > 1.5mm	0					
Fold mark, linear scar for polarizer	Length(mm)	Width(mm)	5 Inch ≤ S < 7 Inch			
	disregard	W ≤ 0.05	allowed	allowed		allowed
	1 < L ≤ 5	0.05 < W ≤ 0.2	3	4		5
	L > 5	W > 0.2	0	0		0
Notes:						
1. If the fold mark and linear scar for polarizer is visible with operating condition, the defect is judged with line judge.						
2. If the fold mark and linear scar for polarizer is visible with non-operating condition, the defect is judged with the above judgment standard.						



12 Handling Precautions

12.1 Mounting method

Do not make extra holes in the display or modify its shape. When mounting the display, ensure that the display does not flex, bend or twist. Extreme care should be used when handling the LCD modules.

12.2 LCD Handling and Cleaning Precaution

To clean the display surface, it is recommended to wipe lightly using a soft cloth with either Isopropyl alcohol or Ethyl alcohol.

Do not wipe the display surface with dry or hard materials as it may damage the polarizer surface.

Do not use Water or Aromatics to clean the display.

Do not wipe ITO pad area with dry or hard materials that will damage the ITO patterns

Do not use Soldering flux, Chlorine(Cl), and Sulfur(S) on the pad or prevent it from being contaminated.

If the display is sent without applying a silicon coat on the pad, the ITO patterns could be damaged due to corrosion as time goes on.

If ITO corrosion occurs due to customer miss-handling, or if the customer applies materials such as Chlorine (Cl), Sulfur (S) to the display, the responsibility is placed the customer.

12.3 Static Charge Precaution

The LCD module uses CMOS LSI drivers, so we recommend that you:

- Connect any unused input terminal to VDD or VSS
- Do not input any signals before power is turned on
- Ground your body, work/assembly areas, and assembly equipment to protect against static electricity.

12.4 Packing

The module employs LCD elements and must be treated as such.

- Avoid intense shock and falls from a height.
- To prevent modules from degradation, do not operate or store them exposed direct to sunshine or high temperature/humidity

12.5 Precautions during Operation

- It is an indispensable condition to drive the LCD module within the specified voltage limits. Applying voltage higher than the limit will reduce the life span of the LCD.
- Using direct drive current should be avoided, as it will induce an electrochemical reaction causing undesirable deterioration.
- The LCD's response time will be delayed when operating at a temperature lower than the suggested operating range. When operating at a temperature higher than the suggested range, the LCD will be noticeably darker. The display will return to normal when it is brought back to the specified operation temperature.
- If the display area is pushed hard during operation, some font may be abnormally drawn but the LCD will return to normal after it is reset.
- Slight dew depositing on terminals can cause an electro-chemical reaction, damaging traces and resulting in an open circuit.

Usage under the maximum operating temperature, 50%Rh or less is required



12.6 Storage Recommendations

When storing the LCD for a prolonged period of time, the following recommendations will help prevent damage or deterioration

- Store the display in an ambient temperature range between 10°C to 30°C, and in a relative humidity of 45% to 75%.
- Do not leave the display exposed to sunlight or fluorescent light.
- Place the display in a polyethylene bag with the opening sealed.
- Ensure that nothing is making contact with the polarizer surface.
- It is recommended to store them in the same packaging that was provided upon purchase

12.7 Safety Precautions

In the case that the LCD glass has shattered, it is recommended to remove any glass pieces, wash off the liquid crystal using either acetone or ethanol, and proceed to burn any remaining display pieces.

If any liquid leaked out of a damaged glass cell, and comes in contact with your hands, please wash it off well with soap and water



13 Ordering

13.1 Part Numbering Scheme

Table 3: Parallel TFT Part Numbering Scheme

MOP	TFT	800	480	70	A	BLM	CTB
1	2	3	4	5	6	7	8

13.2 Options

Table 4: Parallel Part Options

#	Designator	Options
1	Product Line	MOP: Matrix Orbital Parallel Display
2	Screen Type	TFT: Graphic TFT
3	Display Columns	800: Eight Hundred Pixel Columns
4	Display Rows	480: Four Hundred Eighty Pixel Columns
5	Display Size	70: 7.0"
6	Display Form Factor	A: A Form Factor
7	Brightness Level	-BLS: Brightness < 300 Nit -BLM: 300 Nit < Brightness < 600 Nit -BLH: 600 Nit < Brightness < 1000 Nit -BLD: Brightness > 1000 Nit
8	Touch Panel Type	TPN: None TPR: Resistive TPC: Capacitive CTB: Bezel-less Capacitive

14 Contact

Sales

Phone: 403.229.2737

Email: sales@matrixorbital.ca

Support

Phone: 403.204.3750

Email: support@matrixorbital.ca

Online

Purchasing: www.matrixorbital.com

Support: www.matrixorbital.ca

